

- ★ Super Low Gate Charge
- ★ 100% EAS Guaranteed
- ★ Green Device Available
- ★ Excellent CdV/dt effect decline
- ★ Advanced trench gate super junction technology

Product Summary

BVDSS	RDS(ON)	ID
650V	90mΩ	31A

Description

The XR65R90FRFT use super junction technology and design to provide excellent RDS(ON) with low gate charge. This super junction MOSFET fits the industry's AC-DC SMPS requirements for PFC, AC/DC power conversion, and industrial power applications.

The XR65R90FRFT meet the RoHS and Green Product requirement, 100% EAS guaranteed with full function reliability approved.

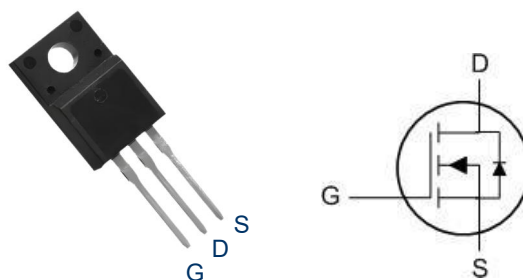
TO220F Pin Configuration

Absolute Maximum Ratings

Symbol	Parameter	Rating	Units
V_{DS}	Drain-Source Voltage	650	V
V_{GS}	Gate-Source Voltage	± 30	V
$I_D@T_C=25^\circ C$	Continuous Drain Current, $V_{GS} @ 10V^{1,6}$	31	A
$I_D@T_C=100^\circ C$	Continuous Drain Current, $V_{GS} @ 10V^{1,6}$	20	A
I_{DM}	Pulsed Drain Current ²	124	A
EAS	Single Pulse Avalanche Energy ³	480	mJ
I_{AS}	Avalanche Current	---	A
$P_D@T_C=25^\circ C$	Total Power Dissipation ⁴	26	W
T_{STG}	Storage Temperature Range	-55 to 150	$^\circ C$
T_J	Operating Junction Temperature Range	-55 to 150	$^\circ C$

Thermal Data

Symbol	Parameter	Typ.	Max.	Unit
$R_{\theta JA}$	Thermal Resistance Junction-Ambient ¹	---	64	$^\circ C/W$
$R_{\theta JC}$	Thermal Resistance Junction-Case ¹	---	4.73	$^\circ C/W$

Electrical Characteristics (T_J=25 °C, unless otherwise noted)

Symbol	Parameter	Conditions	Min.	Typ.	Max.	Unit
BV _{DSS}	Drain-Source Breakdown Voltage	V _{GS} =0V, I _D =250uA	650	---	---	V
ΔBV _{DSS} /ΔT _J	BV _{DSS} Temperature Coefficient	Reference to 25°C, I _D =1mA	---	---	---	V/°C
R _{DS(ON)}	Static Drain-Source On-Resistance ²	V _{GS} =10V, I _D =17A	---	90	103	mΩ
		V _{GS} =4.5V, I _D =7.5A	---	---	---	
V _{GS(th)}	Gate Threshold Voltage	V _{GS} =V _{DS} , I _D =250uA	3.2	---	4.6	V
ΔV _{GS(th)}	V _{GS(th)} Temperature Coefficient		---	---	---	mV/°C
I _{DSS}	Drain-Source Leakage Current	V _{DS} =650V, V _{GS} =0V, T _J =25°C	---	---	5	uA
		V _{DS} =650V, V _{GS} =0V, T _J =150°C	---	800	---	
I _{GSS}	Gate-Source Leakage Current	V _{GS} =±30V, V _{DS} =0V	---	---	±100	nA
g _{fs}	Forward Transconductance	V _{DS} =20V, I _D =17A	---	19	---	S
R _g	Gate Resistance	V _{DS} =0V, V _{GS} =0V, f=1MHz	---	0.9	---	Ω
Q _g	Total Gate Charge	V _{DS} =400V, V _{GS} =10V, I _D =7.5A	---	70	---	nC
Q _{gs}	Gate-Source Charge		---	17	---	
Q _{gd}	Gate-Drain Charge		---	45	---	
T _{d(on)}	Turn-On Delay Time	V _{GS} =10V, V _{DS} =400V, R _G =27Ω, I _D =17A	---	50	---	ns
T _r	Rise Time		---	100	---	
T _{d(off)}	Turn-Off Delay Time		---	180	---	
T _f	Fall Time		---	50	---	
C _{iss}	Input Capacitance	V _{DS} =100V, V _{GS} =0V, f=1MHz	---	1900	---	pF
C _{oss}	Output Capacitance		---	117	---	
C _{rss}	Reverse Transfer Capacitance		---	2.2	---	

Diode Characteristics

Symbol	Parameter	Conditions	Min.	Typ.	Max.	Unit
I _S	Continuous Source Current ^{1,4}	V _G =V _D =0V, Force Current	---	---	31	A
V _{SD}	Diode Forward Voltage ²	V _{GS} =0V, I _S =17A, T _J =25°C	0.7	0.9	1.1	V
t _{rr}	Reverse Recovery Time	I _F =17, di/dt=100A/μs,	---	140	---	nS
Q _{rr}	Reverse Recovery Charge	T _J =25°C	---	0.89	---	nC

Note :

1 The data is tested by surface mounted on a 1 inch² FR-4 board with 2OZ copper.

2 The data is tested by pulsed pulse width ≤ 300us duty cycle ≤ 2%

3 The EAS data shows Max. rating. The test condition is V_{RMS} > 0, V_D=200V, V_{GS}=10V, L=30mH

4 The power dissipation is limited by 150°C junction temperature

5 The data is theoretically the same as I_{SD} and I_{OMA}. In real applications it should be limited by total power

dissipation.

Typical Performance Characteristics

Fig 1. Output Characteristics ($T_j=25^\circ\text{C}$)

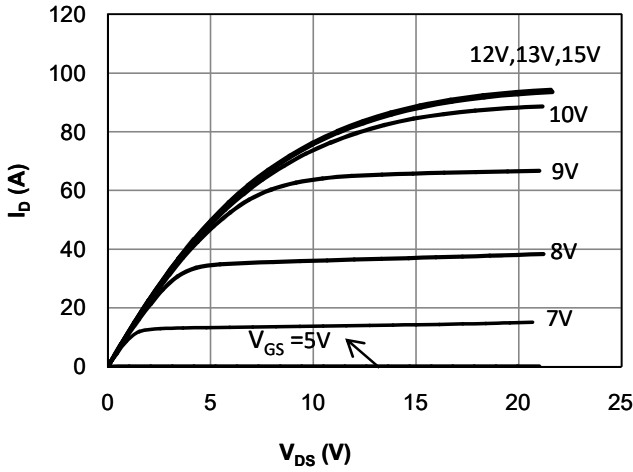

Fig 2. Output Characteristics ($T_j=150^\circ\text{C}$)

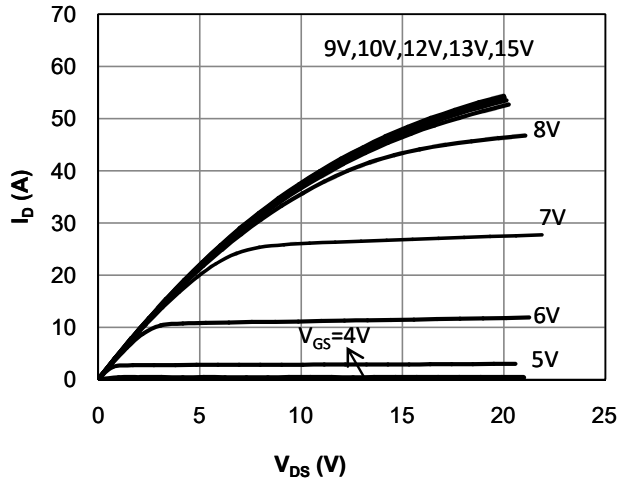

Fig 3: Transfer Characteristics

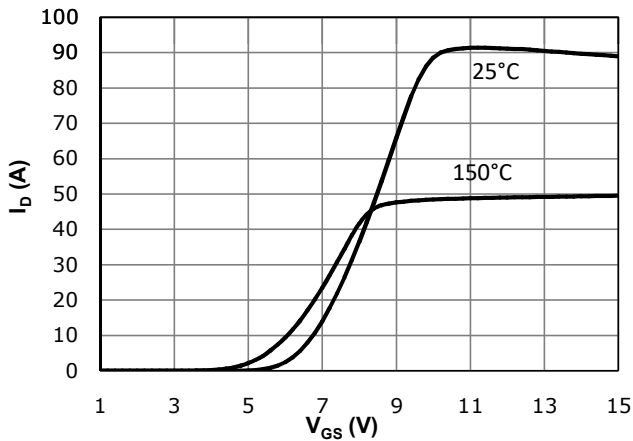

Fig 4: V_{TH} Vs. T_j Temperature Characteristics

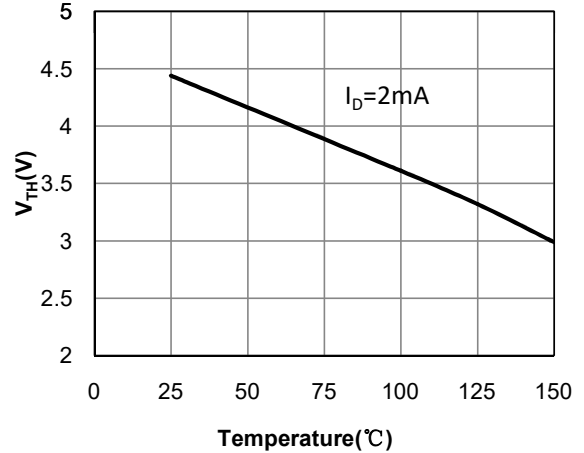

Fig 5: $R_{DS(on)}$ vs. I_{DS} Characteristics ($T_j=25^\circ\text{C}$)

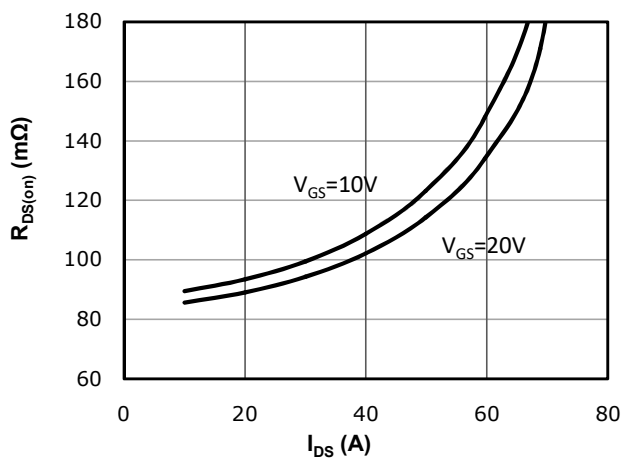
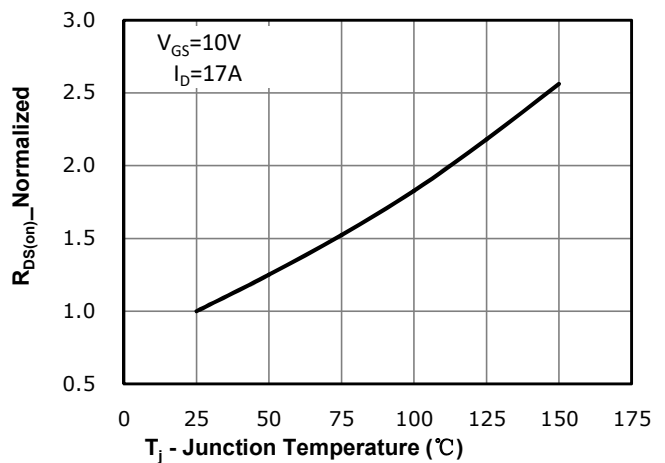

Fig 6: $R_{DS(on)}$ vs. Temperature



650V Super Junction Power MOSFET

Fig 7: BV_{DSS} vs. Temperature

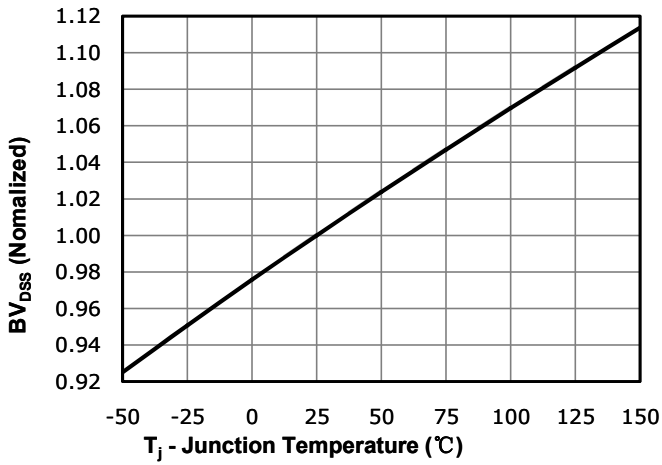

Fig 8: $R_{DS(on)}$ vs. Gate Voltage

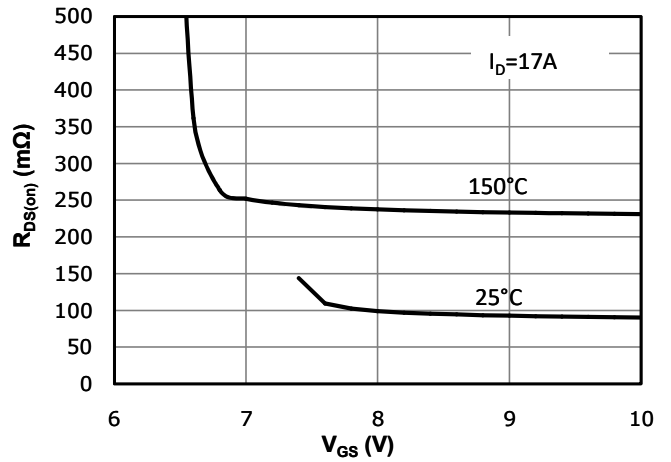

Fig 9: Body-diode Forward Characteristics

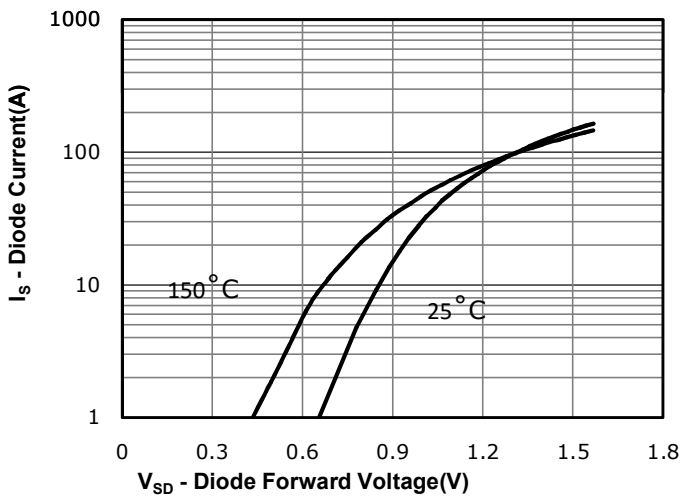

Fig 10: Gate Charge Characteristics

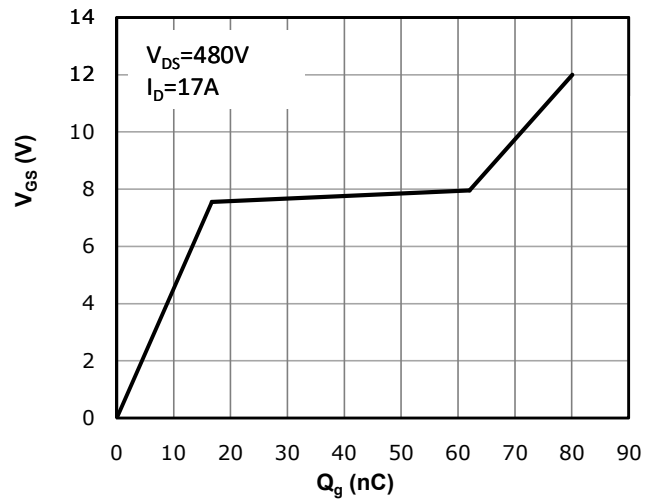

Fig 11: Capacitance Characteristics

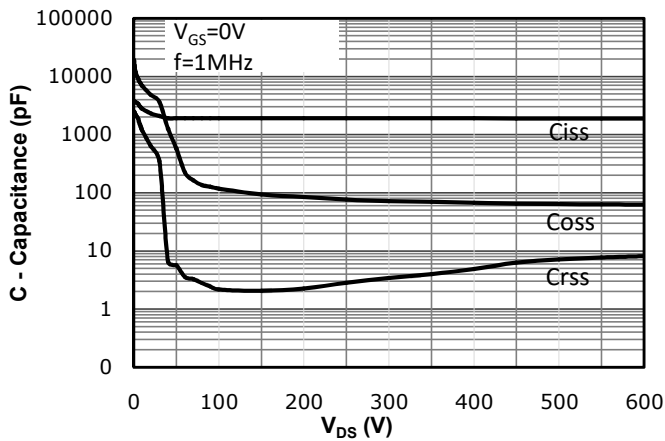

Fig 12: Safe Operating Area

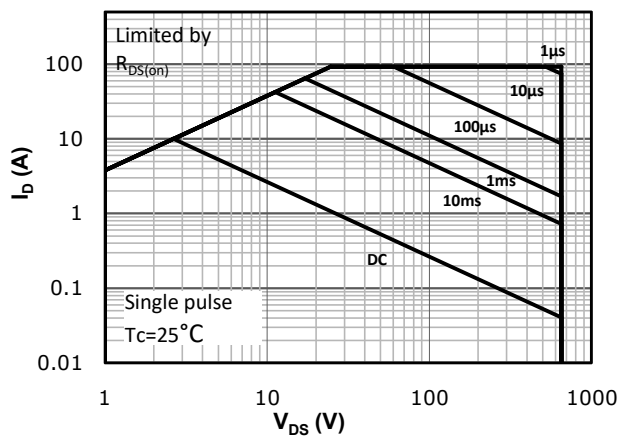
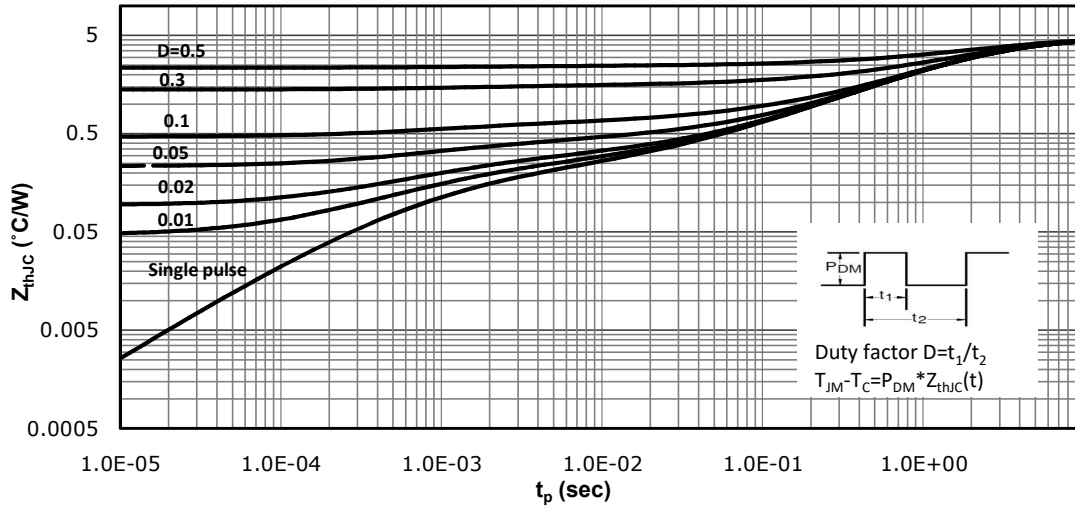
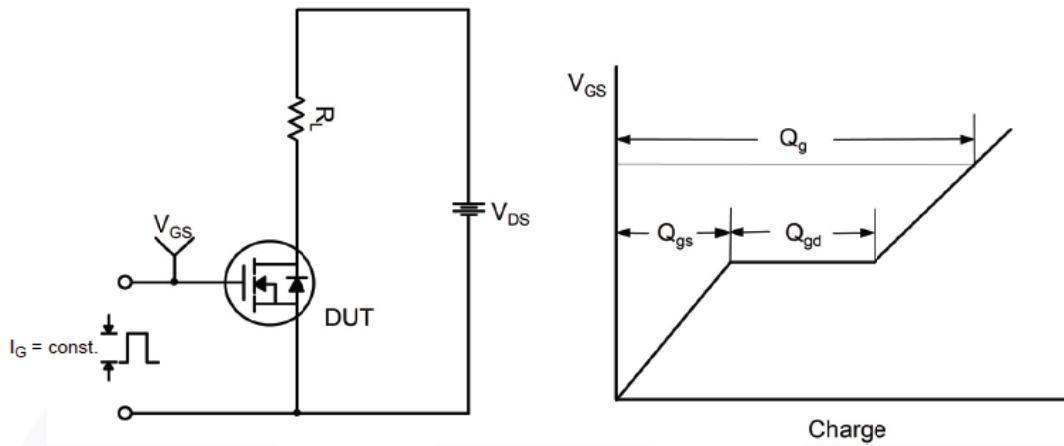

Fig 13: Max. Transient Thermal Impedance



Gate Charge Test Circuit & Waveform



Switching Test Circuit & Waveforms

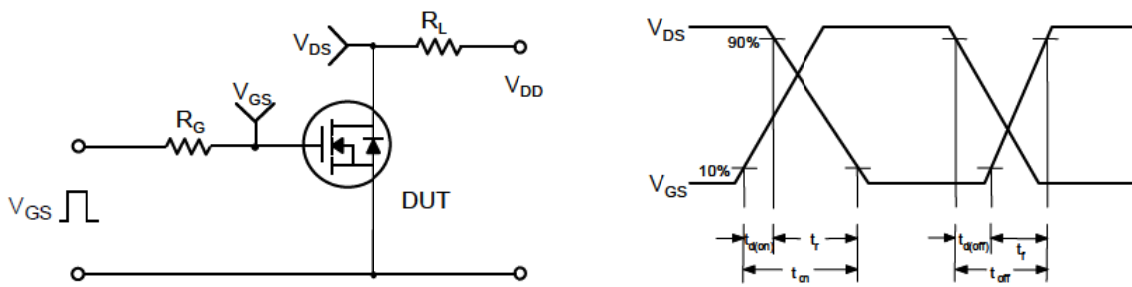

Unclamped Inductive Switching Test Circuit & Waveforms

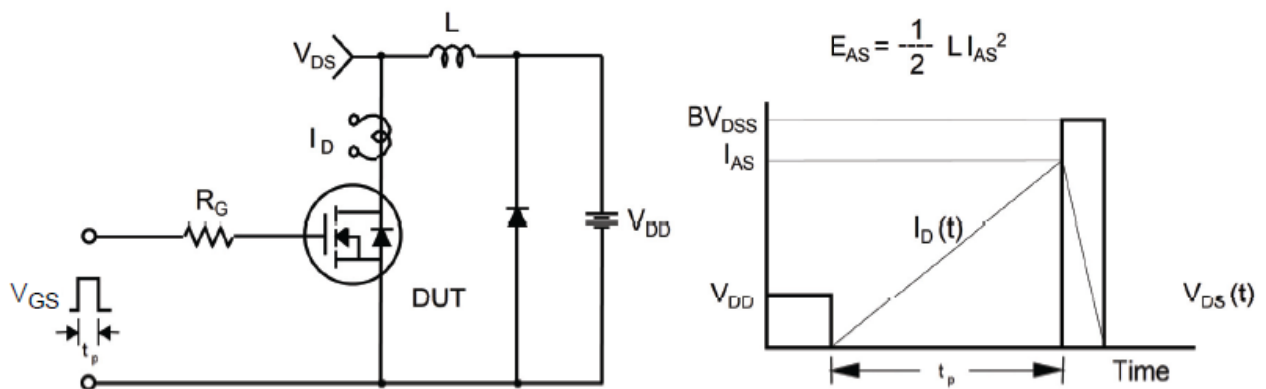

Mechanical Dimensions for TO-220F

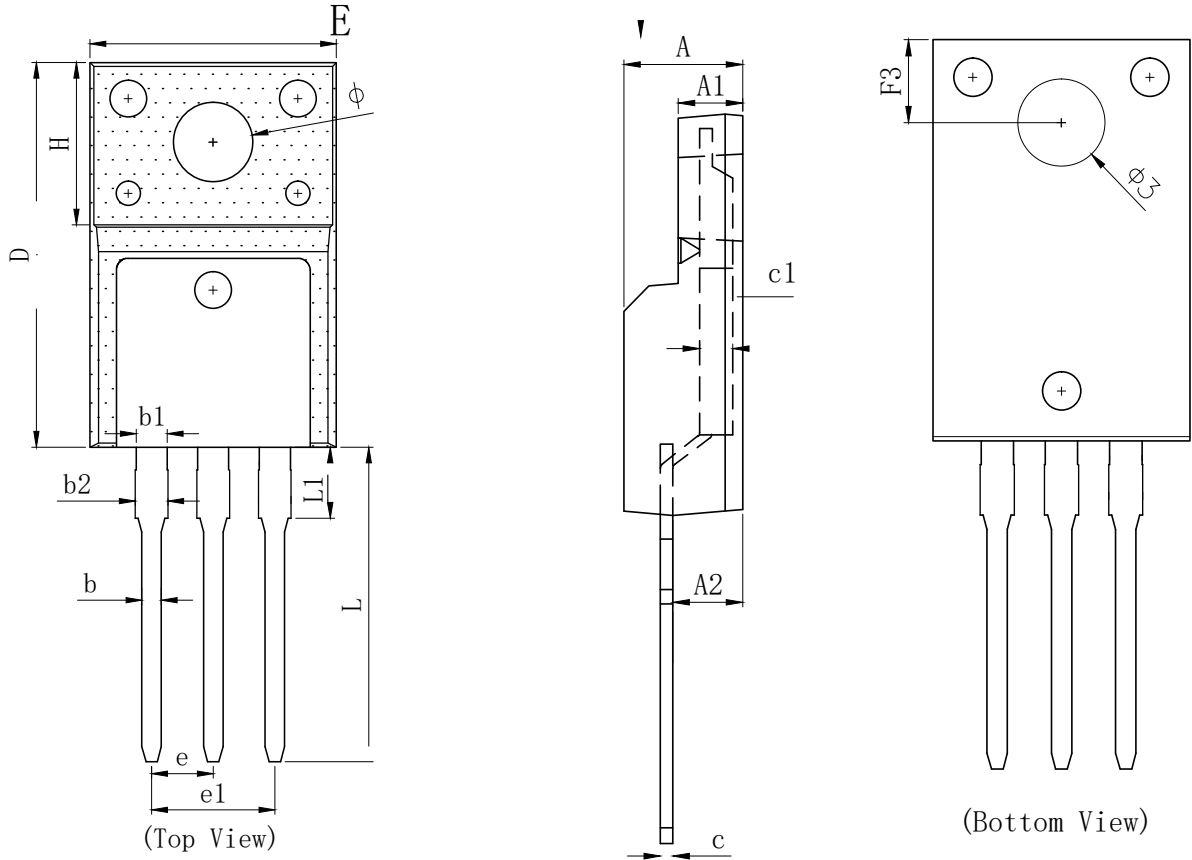

SYMBOL	MILLIMETER		
	MIN	Typ.	MAX
A	4.500	4.700	4.900
A1	2.340	2.540	2.740
A2	2.560	2.760	2.960
b	0.700	0.800	0.950
b1	1.180	1.280	1.430
b2	1.250	1.350	1.550
c	0.400	0.500	0.650
c1	1.200	1.300	1.350
D	15.570	15.870	16.170
H	6.700 REF		
E	9.960	10.160	10.360
e	2.540 BSC		
e1	5.080 BSC		
L	12.680	12.980	13.280
L1	2.780	2.930	3.080
F3	3.150	3.300	3.450
ϕ	3.030	3.180	3.450
$\phi 3$	3.150	3.450	3.650