

- ★ 100% EAS Guaranteed
- ★ Green Device Available
- ★ Super Low Gate Charge
- ★ Excellent CdV/dt effect decline
- ★ Advanced high cell density Trench technology

Product Summary



BVDSS	R _{DS(on)}	I _D
40V	18.0 mΩ	30A

Description

The XR30N04 is the high cell density trenched N-ch MOSFETs, which provide excellent R_{DS(on)} and gate charge for most of the synchronous buck converter applications.

The XR30N04 meet the RoHS and Green Product requirement, 100% EAS guaranteed with full function reliability approved.

TO252 Pin Configuration

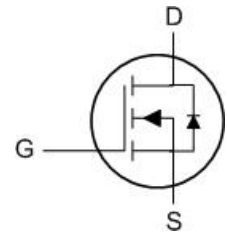
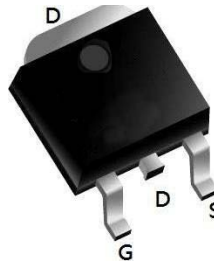

Absolute Maximum Ratings

Symbol	Parameter	Rating	Units
V _{DS}	Drain-Source Voltage	40	V
V _{GS}	Gate-Source Voltage	±20	V
I _D @T _C =25°C	Continuous Drain Current, V _{GS} @ 10V ¹	30	A
I _D @T _C =100°C	Continuous Drain Current, V _{GS} @ 10V ¹	15	A
I _{DM}	Pulsed Drain Current ²	40	A
EAS	Single Pulse Avalanche Energy ³	17.1	mJ
I _{AS}	Avalanche Current	10	A
P _D @T _C =25°C	Total Power Dissipation ⁴	4	W
T _{STG}	Storage Temperature Range	-55 to 150	°C
T _J	Operating Junction Temperature Range	-55 to 150	°C

Thermal Data

Symbol	Parameter	Typ.	Max.	Unit
R _{θJA}	Thermal Resistance Junction-ambient (Steady State) ¹	---	62	°C/W
R _{θJC}	Thermal Resistance Junction-Case ¹	---	2.8	°C/W

N-Channel Electrical Characteristics (T_J=25°C unless otherwise specified)

Symbol	Parameter	Test Condition	Min.	Typ.	Max.	Units
Off Characteristic						
V _{(BR)DSS}	Drain-Source Breakdown Voltage	V _{GS} =0V, I _D =250μA	40	-	-	V
I _{DSS}	Zero Gate Voltage Drain Current	V _{DS} =40V, V _{GS} =0V	-	-	1.0	μA
I _{GSS}	Gate to Body Leakage Current	V _{DS} =0V, V _{GS} =±20V	-	-	±100	nA
On Characteristics						
V _{GS(th)}	Gate Threshold Voltage	V _{DS} =V _{GS} , I _D =250μA	1.0	1.5	2.5	V
R _{DS(on)}	Static Drain-Source on-Resistance <small>note3</small>	V _{GS} =10V, I _D =8A	-	18	22	mΩ
		V _{GS} =4.5V, I _D =5A	-	25	35	mΩ
Dynamic Characteristics						
C _{iss}	Input Capacitance	V _{DS} =20V, V _{GS} =0V, f=1.0MHz	-	633	-	pF
C _{oss}	Output Capacitance		-	67	-	pF
C _{rss}	Reverse Transfer Capacitance		-	58	-	pF
Q _g	Total Gate Charge	V _{DS} =20V, I _D =8A, V _{GS} =10V	-	12	-	nC
Q _{gs}	Gate-Source Charge		-	3.2	-	nC
Q _{gd}	Gate-Drain("Miller") Charge		-	3.1	-	nC
Switching Characteristics						
t _{d(on)}	Turn-on Delay Time	V _{DD} = 20V, R _L =2.5Ω V _{GS} =10V, R _{REN} =3Ω	-	4	-	ns
t _r	Turn-on Rise Time		-	3	-	ns
t _{d(off)}	Turn-off Delay Time		-	15	-	ns
t _f	Turn-off Fall Time		-	2	-	ns
Drain-Source Diode Characteristics and Maximum Ratings						
I _S	Maximum Continuous Drain to Source Diode Forward Current		-	-	30	A
I _{SM}	Maximum Pulsed Drain to Source Diode Forward Current		-	-	40	A
V _{SD}	Drain to Source Diode Forward Voltage	V _{GS} =0V, I _S = 8A	-	-	1.2	V

Notes:1. Repetitive Rating: Pulse Width Limited by Maximum Junction Temperature

2. EAS condition : T_J=25°C, V_{DD}=20V, V_G=10V, L=0.5mH, R_g=25Ω, I_{AS}=7.2A

T_J=25°C, V_{DD}=-20V, V_G= -10V, L=0.5mH, R_g=25Ω, I_{AS}=-8.4A

3. Pulse Test: Pulse Width≤300μs, Duty Cycle≤2%

Typical Performance Characteristics-N

Figure 1: Output Characteristics

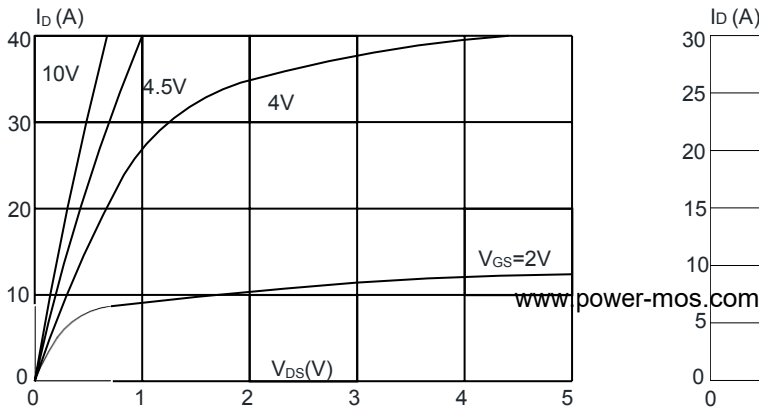

Figure 2: Typical Transfer Characteristics

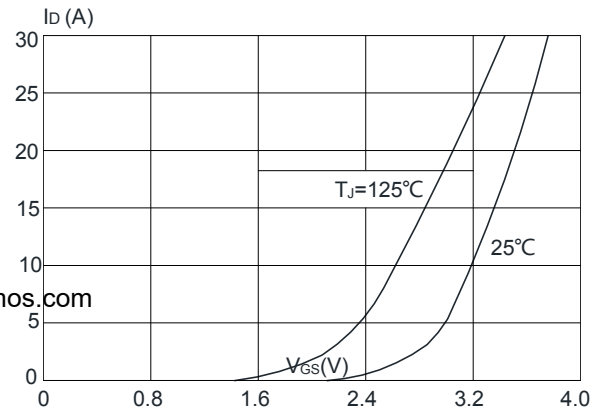

Figure 3: On-resistance vs. Drain Current

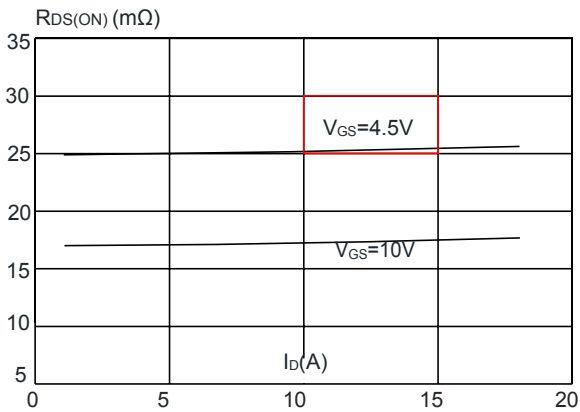

Figure 4: Body Diode Characteristics

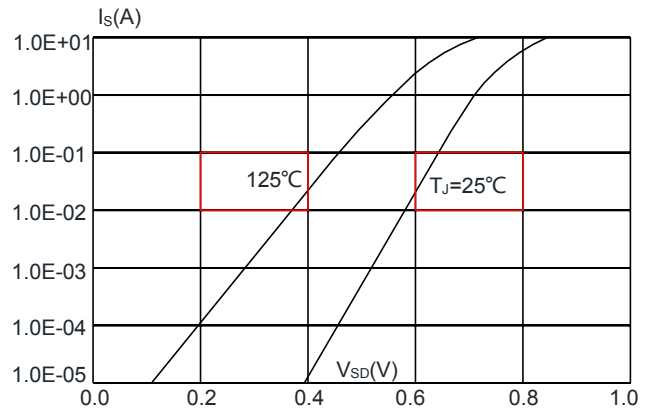

Figure 5: Gate Charge Characteristics

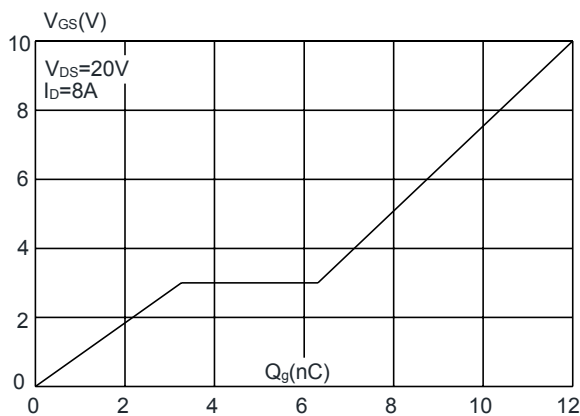

Figure 6: Capacitance Characteristics

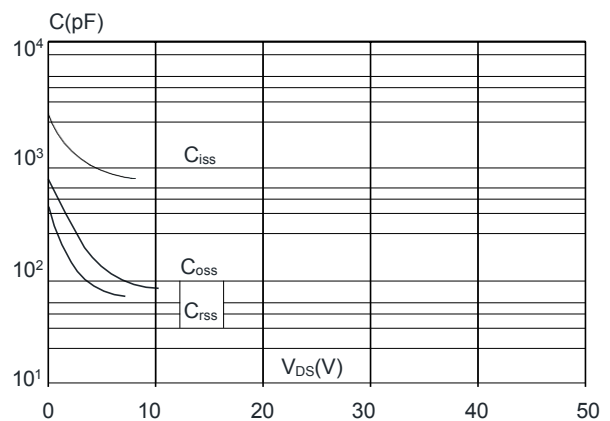

Figure 7: Normalized Breakdown Voltage vs. Junction Temperature

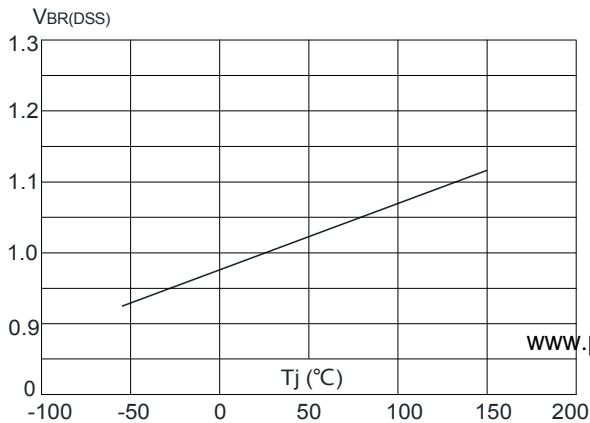

Figure 8: Normalized on Resistance vs. Junction Temperature

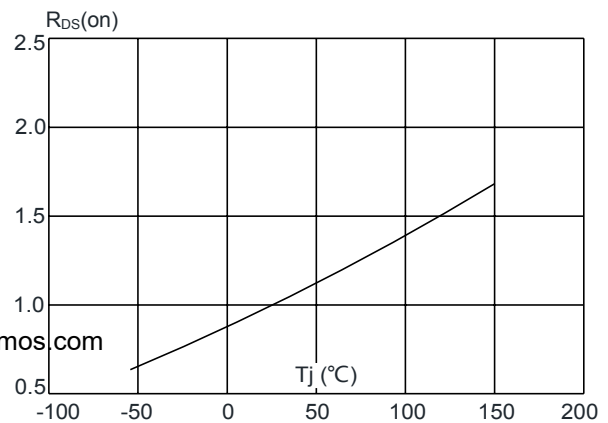

Figure 9: Maximum Safe Operating Area

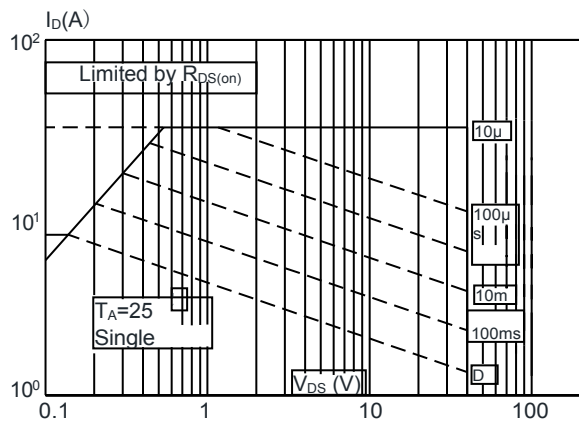

Figure 10: Maximum Continuous Drain Current vs. Ambient Temperature

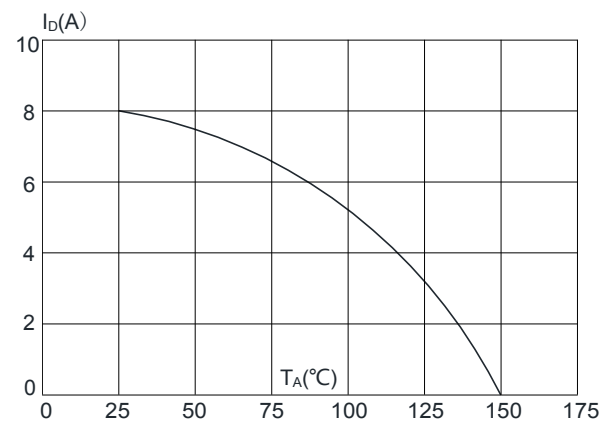
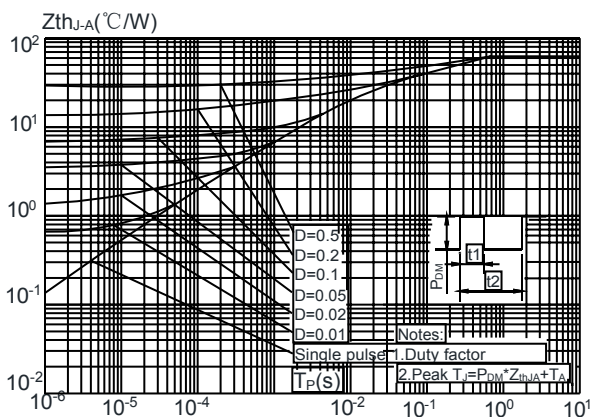
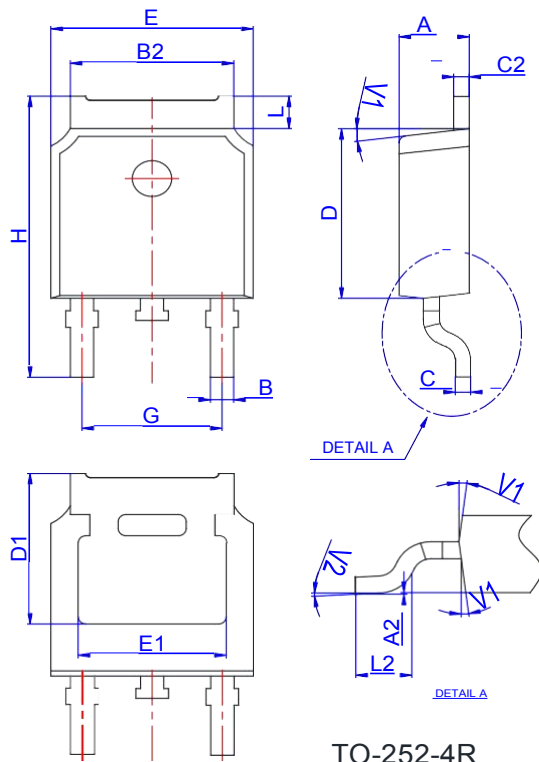

Figure.11: Maximum Effective Transient Thermal Impedance, Junction-to-Ambient



Package Mechanical Data-TO-252-4R



Ref.	Dimensions					
	Millimeters			Inches		
	Min.	Typ.	Max.	Min.	Typ.	Max.
A	2.10		2.50	0.083		0.098
A2	0		0.10	0		0.004
B	0.66		0.86	0.026		0.034
B2	5.18		5.48	0.202		0.216
C	0.40		0.60	0.016		0.024
C2	0.44		0.58	0.017		0.023
D	5.90		6.30	0.232		0.248
D1	5.30REF			0.209REF		
E	6.40		6.80	0.252		0.268
E1	4.63			0.182		
G	4.47		4.67	0.176		0.184
H	9.50		10.70	0.374		0.421
L	1.09		1.21	0.043		0.048
L2	1.35		1.65	0.053		0.065
V1		7°			7°	
V2	0°		6°	0°		6°

Reel Specification-TO-252-4R

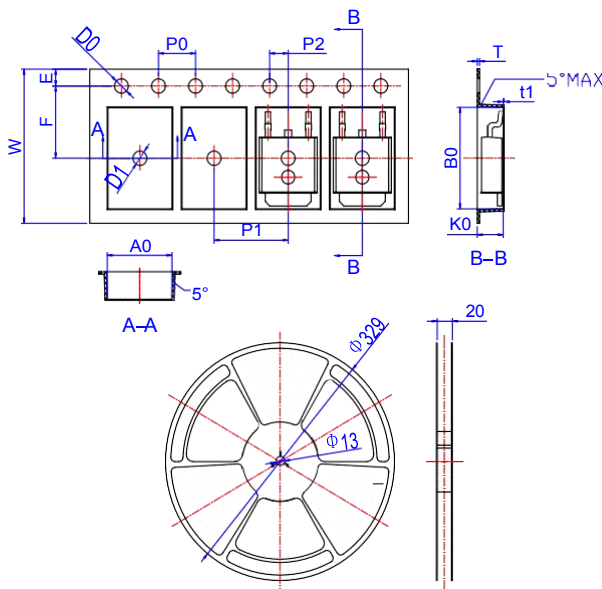

Ref.	Dimensions					
	Millimeters			Inches		
	Min.	Typ.	Max.	Min.	Typ.	Max.
W	15.90	16.00	16.10	0.626	0.630	0.634
E	1.65	1.75	1.85	0.065	0.069	0.073
F	7.40	7.50	7.60	0.291	0.295	0.299
D0	1.40	1.50	1.60	0.055	0.059	0.063
D1	1.40	1.50	1.60	0.055	0.059	0.063
P0	3.90	4.00	4.10	0.154	0.157	0.161
P1	7.90	8.00	8.10	0.311	0.315	0.319
P2	1.90	2.00	2.10	0.075	0.079	0.083
A0	6.85	6.90	7.00	0.270	0.271	0.276
B0	10.45	10.50	10.60	0.411	0.413	0.417
K0	2.68	2.78	2.88	0.105	0.109	0.113
T	0.24		0.27	0.009		0.011
t1	0.10			0.004		
10P0	39.80	40.00	40.20	1.567	1.575	1.583