

## N-Ch 100V Fast Switching MOSFETs



- ★ Super Low Gate Charge
- ★ Green Device Available
- ★ Excellent Cdv/dt effect decline
- ★ Advanced high cell density Trench technology

### Product Summary

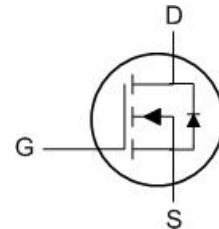
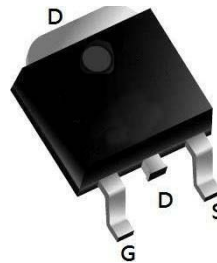
BVDSS	RDSON	ID
100V	15mΩ	50A

### Description

The XR50N10H is the highest performance trench N-ch MOSFETs with extreme high cell density, which provide excellent RDSON and gate charge for most of the synchronous buck converter applications .

The XR50N10H meet the RoHS and Green Product requirement, 100% EAS guaranteed with full function reliability approved.

### TO252-3L Pin Configuration



### Absolute Maximum Ratings (T<sub>C</sub>=25°C unless otherwise specified)

Symbol	Parameter	Max.	Units	
V <sub>DSS</sub>	Drain-Source Voltage	100	V	
V <sub>GSS</sub>	Gate-Source Voltage	±25	V	
I <sub>D</sub>	Continuous Drain Current	T <sub>C</sub> = 25°C	59	A
		T <sub>C</sub> = 100°C	38	A
I <sub>DM</sub>	Pulsed Drain Current <sup>note1</sup>	236	A	
E <sub>AS</sub>	Single Pulsed Avalanche Energy <sup>note2</sup>	110	mJ	
P <sub>D</sub>	Power Dissipation	T <sub>C</sub> = 25°C	153	W
R <sub>θJC</sub>	Thermal Resistance, Junction to Case	0.98	°C/W	
T <sub>J</sub> , T <sub>STG</sub>	Operating and Storage Temperature Range	-55 to +175	°C	

### Electrical Characteristics (T<sub>J</sub>=25°C unless otherwise specified)

Symbol	Parameter	Test Condition	Min.	Typ.	Max.	Units
<b>Off Characteristic</b>						
V <sub>(BR)DSS</sub>	Drain-Source Breakdown Voltage	V <sub>GS</sub> =0V, I <sub>D</sub> =250μA	100	-	-	V
I <sub>DSS</sub>	Zero Gate Voltage Drain Current	V <sub>DS</sub> =100V, V <sub>GS</sub> =0V,	-	-	1.0	μA
I <sub>GSS</sub>	Gate to Body Leakage Current	V <sub>DS</sub> =0V, V <sub>GS</sub> =±25V	-	-	±100	nA
<b>On Characteristics</b>						
V <sub>GS(th)</sub>	Gate Threshold Voltage	V <sub>DS</sub> =V <sub>GS</sub> , I <sub>D</sub> =250μA	2	3	4	V
R <sub>DS(on)</sub>	Static Drain-Source on-Resistance <small>note3</small>	V <sub>GS</sub> =10V, I <sub>D</sub> =30A	-	15	20	mΩ
<b>Dynamic Characteristics</b>						
C <sub>iss</sub>	Input Capacitance	V <sub>DS</sub> =25V, V <sub>GS</sub> =0V, f=1.0MHz	-	5211	-	pF
C <sub>oss</sub>	Output Capacitance		-	232	-	pF
C <sub>rss</sub>	Reverse Transfer Capacitance		-	163	-	pF
Q <sub>g</sub>	Total Gate Charge	V <sub>DS</sub> =30V, I <sub>D</sub> =30A, V <sub>GS</sub> =10V	-	87	-	nC
Q <sub>gs</sub>	Gate-Source Charge		-	27	-	nC
Q <sub>gd</sub>	Gate-Drain("Miller") Charge		-	21	-	nC
<b>Switching Characteristics</b>						
t <sub>d(on)</sub>	Turn-on Delay Time	V <sub>DS</sub> =30V, I <sub>D</sub> =2A, R <sub>L</sub> =15Ω, R <sub>GEN</sub> =2.5Ω, V <sub>GS</sub> =10V	-	18	-	ns
t <sub>r</sub>	Turn-on Rise Time		-	8	-	ns
t <sub>d(off)</sub>	Turn-off Delay Time		-	50	-	ns
t <sub>f</sub>	Turn-off Fall Time		-	20	-	ns
<b>Drain-Source Diode Characteristics and Maximum Ratings</b>						
I <sub>S</sub>	Maximum Continuous Drain to Source Diode Forward Current		-	-	59	A
I <sub>SM</sub>	Maximum Pulsed Drain to Source Diode Forward Current		-	-	236	A
V <sub>SD</sub>	Drain to Source Diode Forward Voltage	V <sub>GS</sub> =0V, I <sub>S</sub> =59A	-	-	1.2	V
trr	Body Diode Reverse Recovery Time	T <sub>J</sub> = 25°C I <sub>F</sub> =28A, di/dt=100A/μs	-	32	-	ns
Q <sub>rr</sub>	Body Diode Reverse Recovery Charge		-	55	-	nC

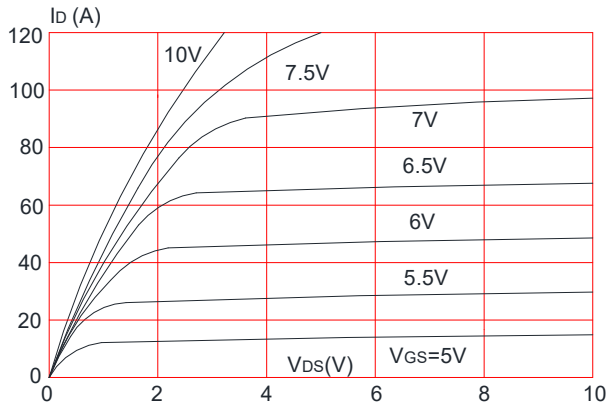
Notes:1. Repetitive Rating: Pulse Width Limited by Maximum Junction Temperature

2. EAS condition: T<sub>J</sub>=25°C, V<sub>DD</sub>=50V, V<sub>G</sub>=10V, L=0.5mH, R<sub>G</sub>=25Ω, I<sub>AS</sub>=21A

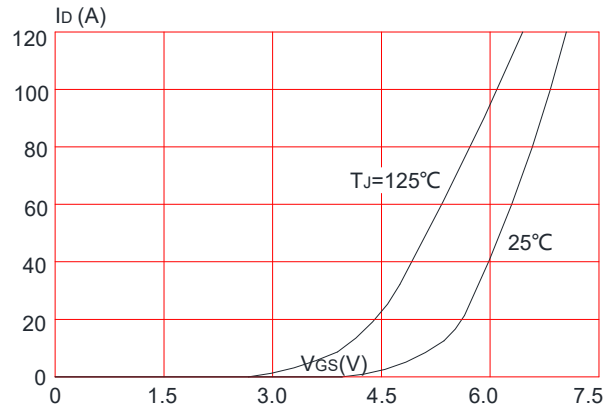
3. Pulse Test: Pulse Width≤300μs, Duty Cycle≤0.5%

### Typical Performance Characteristics

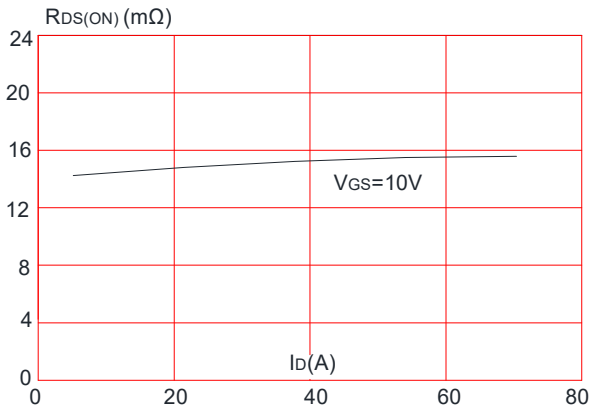
**Figure 1: Output Characteristics**



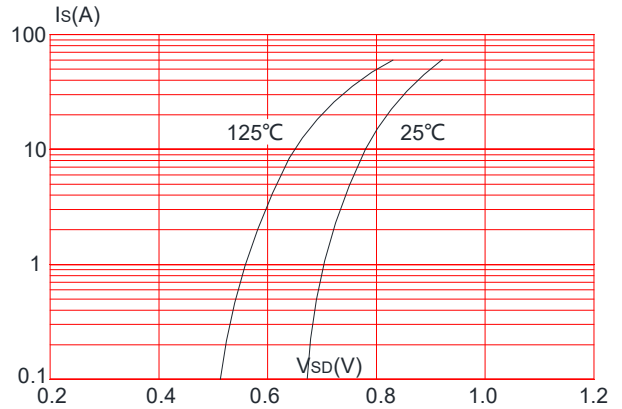
**Figure 2: Typical Transfer Characteristics**



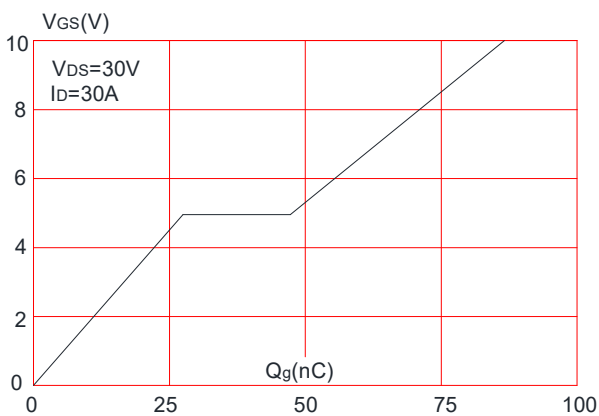
**Figure 3: On-resistance vs. Drain Current**



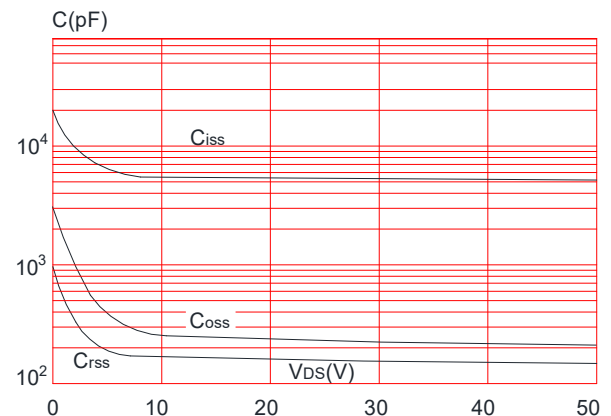
**Figure 4: Body Diode Characteristics**



**Figure 5: Gate Charge Characteristics**

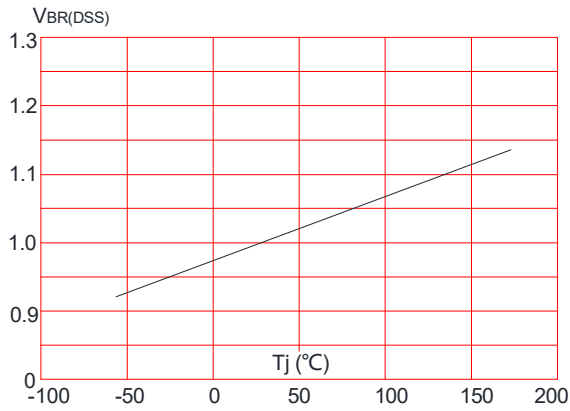


**Figure 6: Capacitance Characteristics**

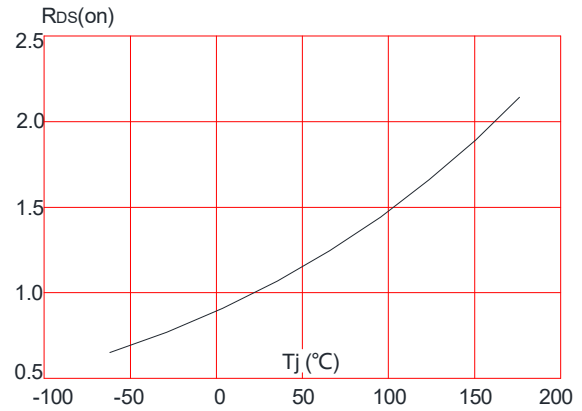


## N-Ch 100V Fast Switching MOSFETs

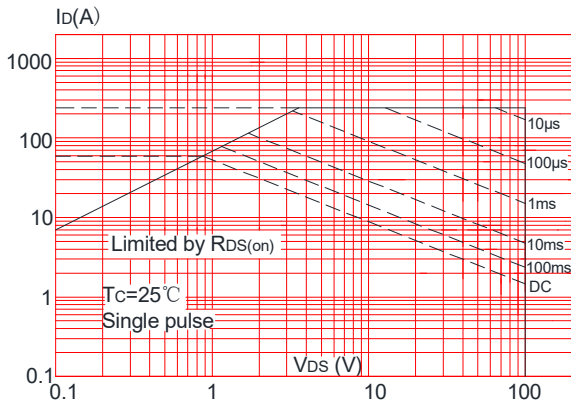
**Figure 7:** Normalized Breakdown Voltage vs. Junction Temperature



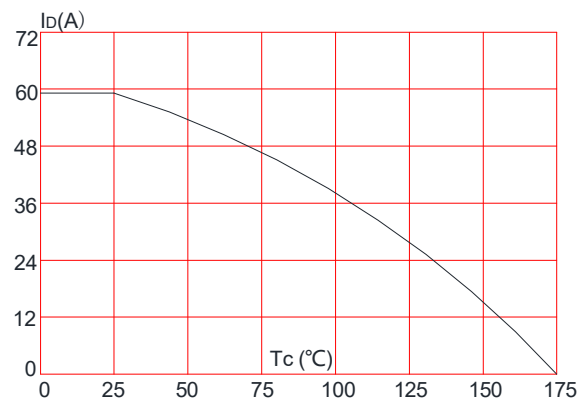
**Figure 8:** Normalized on Resistance vs. Junction Temperature



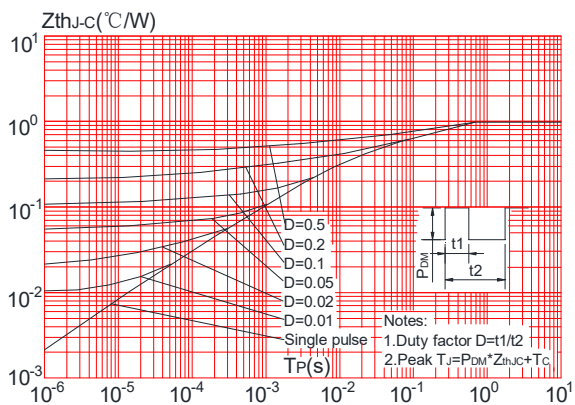
**Figure 9:** Maximum Safe Operating Area



**Figure 10:** Maximum Continuous Drain Current vs. Case Temperature



**Figure.11:** Maximum Effective Transient Thermal Impedance, Junction-to-Case



### Test Circuit

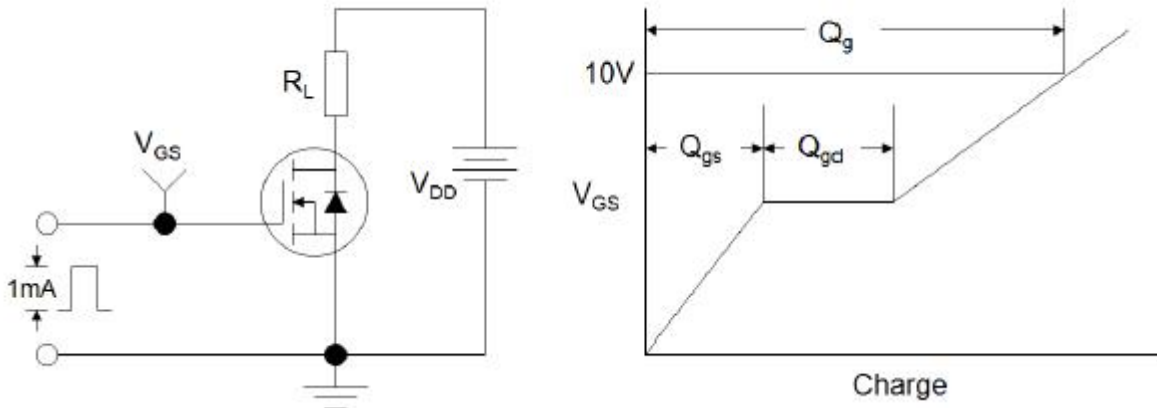


Figure1:Gate Charge Test Circuit & Waveform

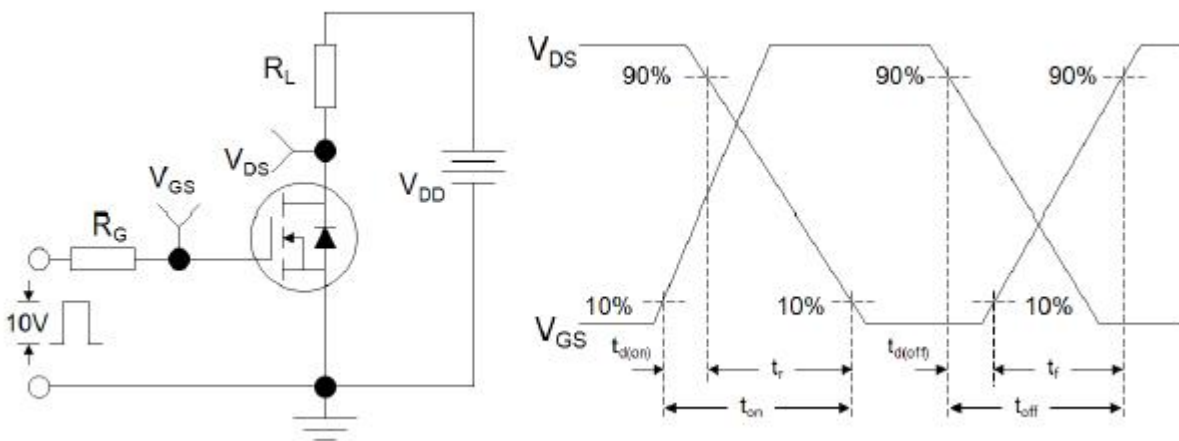


Figure 2: Resistive Switching Test Circuit & Waveforms

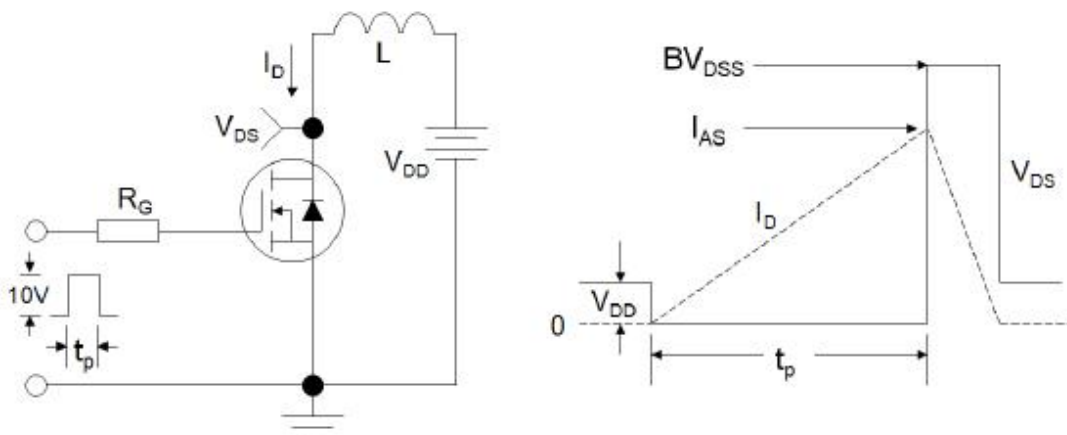
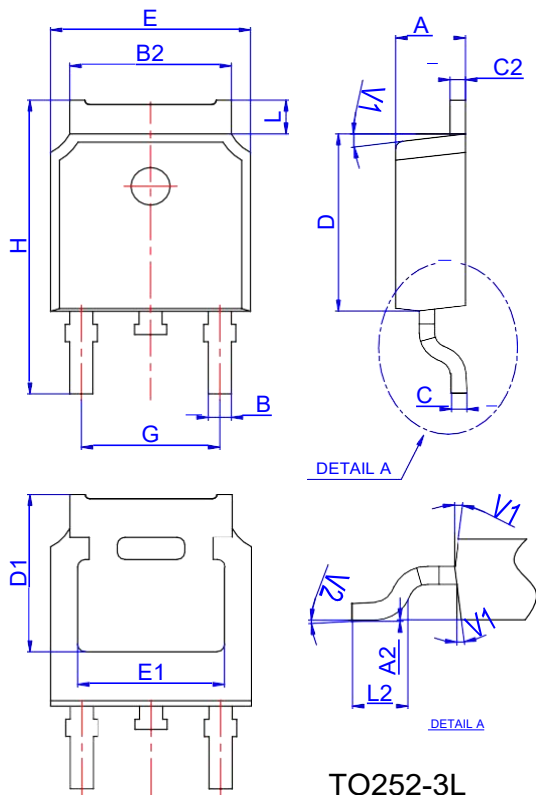


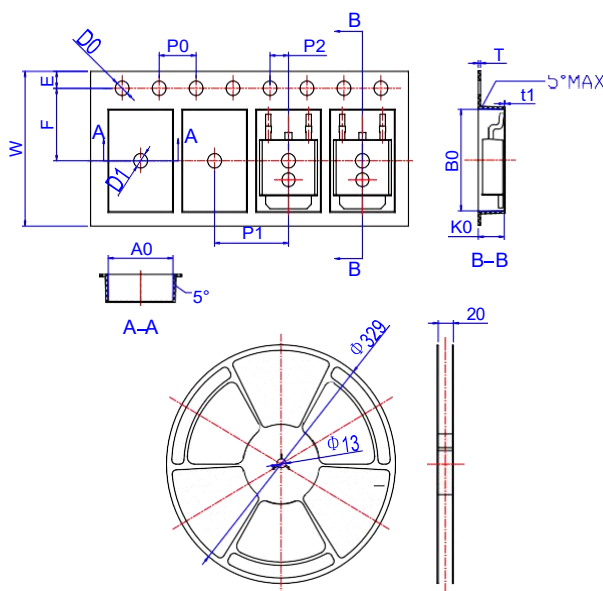
Figure 3:Unclamped Inductive Switching Test Circuit & Waveforms

### Package Mechanical Data TO252-3L



Ref.	Dimensions					
	Millimeters			Inches		
	Min.	Typ.	Max.	Min.	Typ.	Max.
A	2.10		2.50	0.083		0.098
A2	0		0.10	0		0.004
B	0.66		0.86	0.026		0.034
B2	5.18		5.48	0.202		0.216
C	0.40		0.60	0.016		0.024
C2	0.44		0.58	0.017		0.023
D	5.90		6.30	0.232		0.248
D1	5.30REF			0.209REF		
E	6.40		6.80	0.252		0.268
E1	4.63			0.182		
G	4.47		4.67	0.176		0.184
H	9.50		10.70	0.374		0.421
L	1.09		1.21	0.043		0.048
L2	1.35		1.65	0.053		0.065
V1		7°			7°	
V2	0°		6°	0°		6°

### Reel Specification-TO252-3L



Ref.	Dimensions					
	Millimeters			Inches		
	Min.	Typ.	Max.	Min.	Typ.	Max.
W	15.90	16.00	16.10	0.626	0.630	0.634
E	1.65	1.75	1.85	0.065	0.069	0.073
F	7.40	7.50	7.60	0.291	0.295	0.299
D0	1.40	1.50	1.60	0.055	0.059	0.063
D1	1.40	1.50	1.60	0.055	0.059	0.063
P0	3.90	4.00	4.10	0.154	0.157	0.161
P1	7.90	8.00	8.10	0.311	0.315	0.319
P2	1.90	2.00	2.10	0.075	0.079	0.083
A0	6.85	6.90	7.00	0.270	0.271	0.276
B0	10.45	10.50	10.60	0.411	0.413	0.417
K0	2.68	2.78	2.88	0.105	0.109	0.113
T	0.24		0.27	0.009		0.011
t1	0.10			0.004		
10P0	39.80	40.00	40.20	1.567	1.575	1.583